

# Wichita

Model # WC.368.00

3-Compartment Industrial Sink

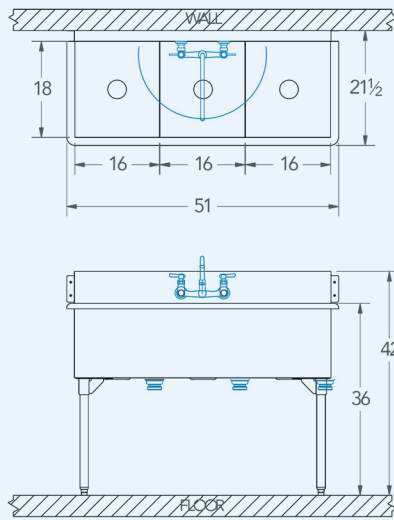

### Bowl (Lg x Wd x Dp)

16" x 18" x 14"

### Drainboard

Left: 0"

Right: 0"

### Overall (Lg x Wd x Ht)

51" x 21 1/2" x 42"

### Material

14 gauge, stainless steel

### Faucet Holes

1-1/8" Dia 8" Centers

### Drain

3-1/2" Dia Opening

### Included:



Matched Faucet



Basket Drain(s)



Install Kit

### Additional Features

- 14 gauge stainless steel
- 12 gauge partition(s)
- 14" deep to sink rim
- Robust retro styling
- Stainless steel legs & feet
- 1-1/2" sanitary rolled-rim
- D 3-1/2" recessed drain opening
- Integrated security flange
- Specification grade hardware included
- 10-year warranty
- Made in Texas