

# Paluxy

Model # PA.72FP

Flush Pipe Urinal

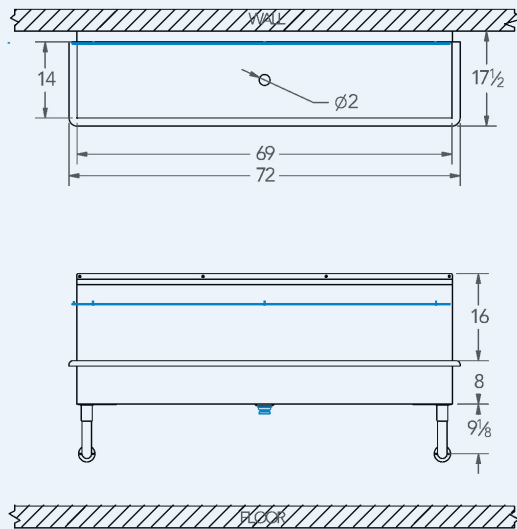

### Bowl (Lg x Wd x Dp)

69" x 14" x 8"

### Overall (Lg x Wd)

72" x 17.5"

### Faucets

N/A

### Material

16 gauge, stainless steel

### Faucet Holes

N/A

### Drain

2" Dia Opening

### Additional Features

- Stainless steel tubular mounting brackets
- Comes with flush tube and keystone
- Tile edge with holes for ease of installation
- Strainer drain
- 10 year warranty
- 1 - 1/2 inch sanitary rolled rim
- Made in Texas