

SECTION A-A
SCALE 1:12

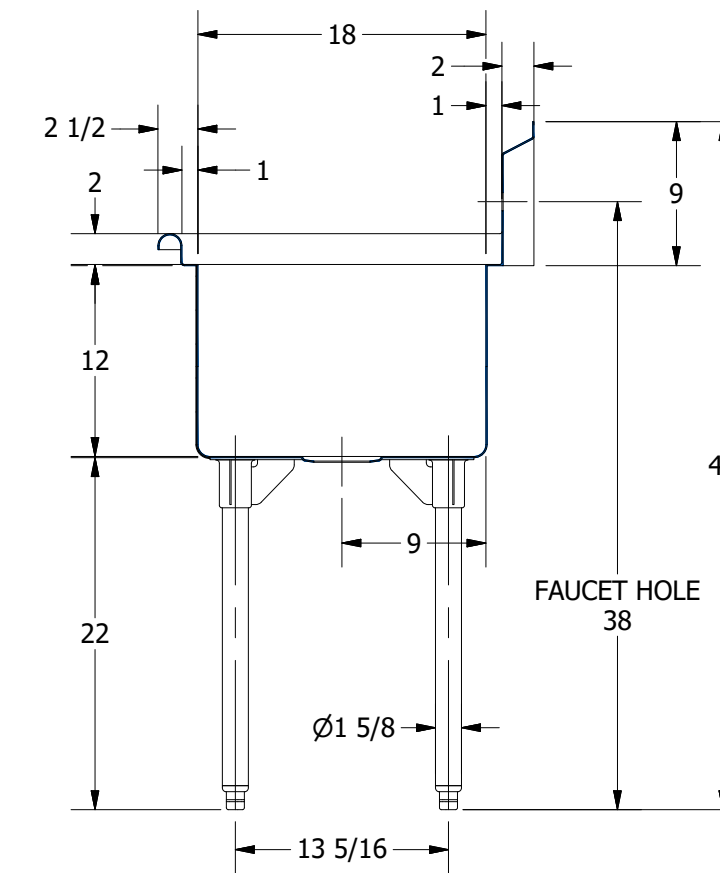

SECTION B-B
SCALE 1:12

REV	DESCRIPTION	DATE	APPROVED
REVISION HISTORY			



PART NUMBER	288.08	TITLE	TRINITY SERIES SCULLERY SINK
PRODUCT CATEGORY	SCULLERY SINK	DESCRIPTION	14GA 2 COMPARTMENTS SINK WITH RIGHT DRAINBOARD
THE INFORMATION CONTAINED IN THIS DRAWING IS THE SOLE PROPERTY OF GRIFFIN PRODUCTS, INC. ANY REPRODUCTION IN PART OR AS A WHOLE WITHOUT THE WRITTEN PERMISSION FROM GRIFFIN PRODUCTS, INC. IS PROHIBITED.		MATERIAL	14GA (0.075 in) 304 STAINLESS STEEL
DRW. BY / DATE	DNZ 01/24/18	APPROVED BY / DATE	
		ALL DIMENSIONS ARE IN X INCHES	
REV.	SCALE	SIZE	SHEET
	1:12	C	1 / 1